

# Quadratec® 1 3/4" Coil Spacer Lift Kit

Installation Manual: for 97-06 Wrangler (TJ & LJ)

#16400.0X31



## PARTS LIST:

- TJ 1 3/4" Coil Spacers - QTY 4
- Bump Stop Extensions - QTY 4
- Front Shocks - QTY 2
- Rear Socks - QTY 2

### **⚠ WARNING ⚠**

**TO REDUCE RISK OF SERIOUS INJURY OR PROPERTY DAMAGE: READ ALL SAFETY MESSAGES AND UNDERSTAND ALL INSTRUCTIONS AND PROCEDURE NOTICES BEFORE ATTEMPTING TO INSTALL OR USE THIS PRODUCT. FOLLOW ALL INSTRUCTIONS AND WARNINGS WITH PRODUCT & VEHICLE OWNERS MANUAL.**

### **⚠ WARNING ⚠**

**THIS KIT INCLUDES A COCKPIT SAFETY WARNING STICKER REGARDING INCREASED ROLLOVER RISK. THIS STICKER MUST BE AFFIXED IN THE COCKPIT, VISIBLE TO ALL VEHICLE OCCUPANTS AT ALL TIMES.**

### **⚠ CAUTION ⚠**

**RISK OF EYE INJURY! SAFETY GLASSES MUST BE WORN AT ALL TIMES WHILE INSTALLING OR MAINTAINING THIS PRODUCT. TORQUE AND RECHECK FASTENERS AFTER 250 MILES AND FREQUENTLY THEREAFTER. DO NOT USE IF DAMAGED.**



**The Trusted Source**

**A Few Words About Product Safety:**

Your Quadratec Suspension product is intended to enhance the utility and enjoyment of your off road capable vehicle. Before installation, please review the following safety information and installation recommendations.

Throughout these instructions important safety information is generally preceded by one of three signal words indicating the relative risk of injury, property damage or adverse consequence. *The signal words mean:*

<b>⚠ WARNING ⚠</b>	a hazardous situation which, if not avoided, could result in death or serious injury. You CAN be KILLED or SERIOUSLY HURT if you don't follow instructions.
<b>⚠ CAUTION ⚠</b>	a hazardous situation which, if not avoided, could result in minor or moderate injury. You CAN be moderately HURT and also may suffer property damage if you don't follow instructions.
<b>NOTICE</b>	Careful attention is required to this instruction or operation but does generally not relate to personal injury. Damage to your Quadratec® product or other property may result if you don't follow instructions.

**Before You Begin Installation:**

Congratulations on your purchase of the Quadratec 1¾" Lift Kit for 1997-2006 TJ Wrangler Vehicles. When unpacking, check to make sure all parts are

included and not damaged due to shipping. If any part is missing or broken, please call Customer Service at 800-745-6037 as soon as possible.

**IMPORTANT PRODUCT SAFETY TIPS**

<b>⚠ WARNING ⚠</b>	<b>INSTALLATION OF THIS PRODUCT ON YOUR JEEP® WILL MODIFY AND ENHANCE ITS SUSPENSION AND OFF-ROAD PERFORMANCE. IT MAY HANDLE DIFFERENTLY THAN AS FACTORY-EQUIPPED INCLUDING; INCREASED RIDE-HEIGHT; REDUCED LATERAL STABILITY; AND HIGHER RISK OF ROLL-OVER OR OTHER ACCIDENT. ALSO, OWNER'S CHOICE OF LARGER TIRE/WHEEL COMBINATIONS MAY REQUIRE ADDITIONAL PEDAL PRESSURE OR INCREASED DISTANCE TO STOP; CAUSE SPEEDOMETER TO READ SLOW AND MAY REDUCE VISIBILITY AROUND THE VEHICLE. CHOICE OF TIRE/WHEEL COMBINATIONS OTHER THAN AS TESTED OR RECOMMENDED MAY COMPROMISE FMVSS 126 COMPATIBILITY.</b>
<b>⚠ WARNING ⚠</b>	<b>FAMILIARIZE YOURSELF WITH VEHICLE HANDLING AND REVIEW ALL VEHICLE MANUFACTURERS AND QUADRATEC® WARNINGS, INSTRUCTIONS AND LIMITED WARRANTIES BEFORE DRIVING A MODIFIED SUSPENSION JEEP®. FOLLOW ALL RECOMMENDED MAINTENANCE PROCEDURES AND ROUTINELY INSPECT YOUR VEHICLE COMPONENTS FOR UNUSUAL WEAR OR OFF-ROAD DAMAGE.</b>
<b>⚠ WARNING ⚠</b>	<b>DO NOT DRIVE UNDER ANY SPEED OR MANEUVERING CONDITIONS WHICH MAY CAUSE THE VEHICLE TO TRIP, ROLL, LOSE TRACTION OR COMPROMISE YOUR ABILITY TO SAFELY BRAKE IN AN EMERGENCY. QUADRATEC® DOES NOT RECOMMEND COMBINED USE OF SUSPENSION KITS, BODY LIFTS, OTHER LIFTING DEVICES OR COMPONENTS ALTERING THE INTENDED RIDE-HEIGHT OR FUNCTION OF ITS PRODUCTS. MANY STATES HAVE LAWS RESTRICTING THE EXTENT OF VEHICLE MODIFICATIONS. OWNER/DRIVER IS RESPONSIBLE FOR MODIFICATIONS CONSISTENT WITH STATE LAWS AND GOOD SENSE.</b>



**The Trusted Source**

## IMPORTANT PRODUCT SAFETY TIPS



QUADRATEC® RECOMMENDS PROFESSIONAL INSTALLATION OF THIS PRODUCT.

### PARTS LIST:

TJ 1 3/4" Coil Spacers - QTY 4  
Bump Stop Extensions - QTY 4  
Front Shocks - QTY 2  
Rear Shocks - QTY 2

### REQUIRED TOOLS:

Safety Glasses  
13mm Open End Wrench  
15mm Open End Wrench  
18mm Open End Wrench  
T40 Torx Socket  
T55 Torx Socket  
13mm Deep Well Socket  
15mm Socket  
9/16" Socket  
17mm Socket  
18mm Socket



PARK THE VEHICLE ON FLAT, LEVEL GROUND AND SET EMERGENCY BRAKE. ALWAYS SUPPORT FRAME RAILS USING JACK STANDS.

### 1.75" Coil Spacer Kit Installation: Front

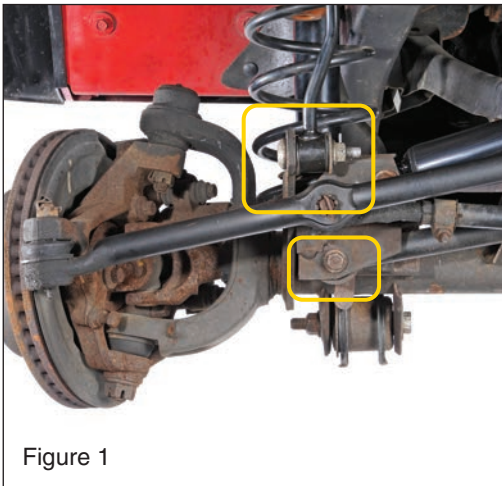

Figure 1

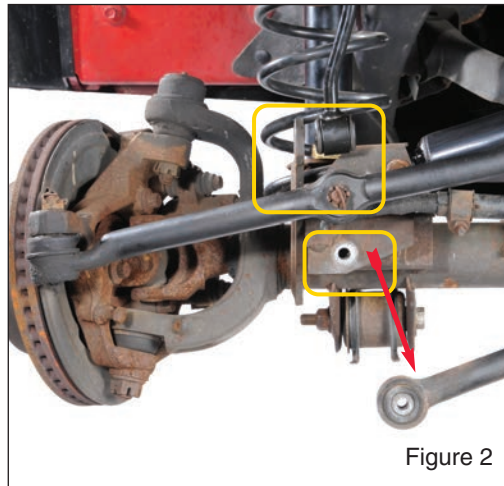

Figure 2

**Caution:** Park the vehicle on flat, level ground and set emergency brake. Put on safety glasses. Raise the front of the vehicle and support frame rails using jack stands. Do not lower the axle at this time. Remove front tires/wheels.

Disconnect the front sway bar end links using a 18mm open end wrench and T55 Torx socket. Disconnect front track bar using a 15mm socket. (see FIG 1 & 2)



The Trusted Source

### 1.75" Coil Spacer Kit Installation: Front

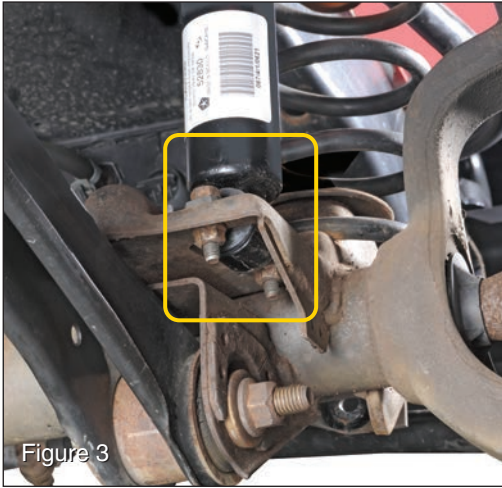

Figure 3

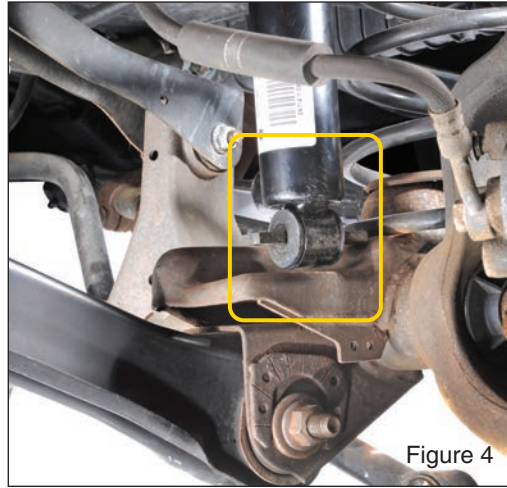

Figure 4

*Disconnect the bottom end of the front shocks using a 13mm deep well socket and open end wrench. (see FIG 3 & 4)*

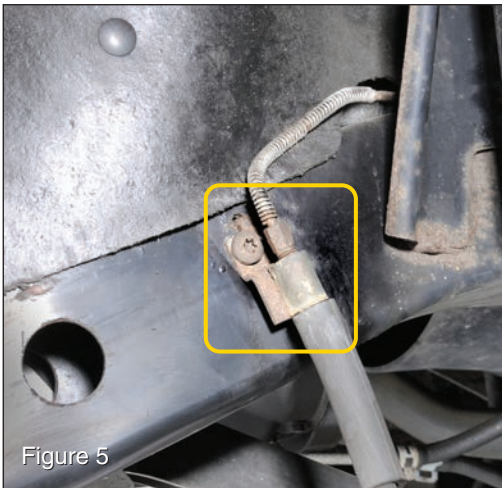

Figure 5

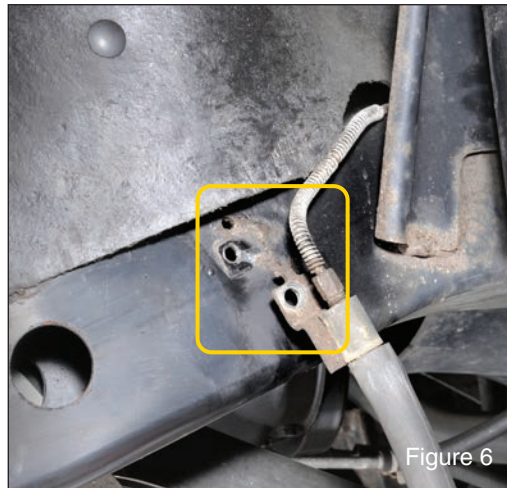

Figure 6

*Disconnect brake line bracket from frame using a T40 Torx socket. (see FIG 5 & 6)*



**The Trusted Source**

## 1.75" Coil Spacer Kit Installation: Front

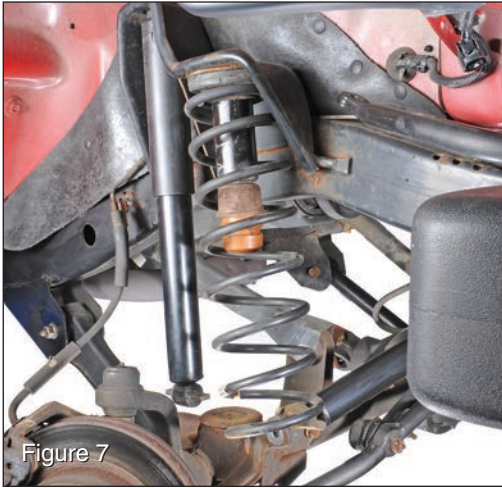

Gently lower axle housing towards the ground and remove original coil springs. (see FIG 7)

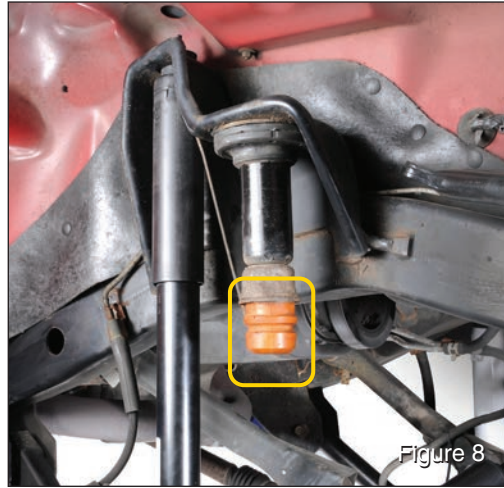

Remove original bump stop by pulling downward and twisting. (see FIG 8).

### **⚠ CAUTION ⚠**

**COIL SPRING MAY BE UNDER TENSION. REMOVE CAREFULLY. INSTALL COIL SPACERS EXACTLY AS SHOWN.**



Remove bump stop cup using a 15mm socket (see FIG 9)

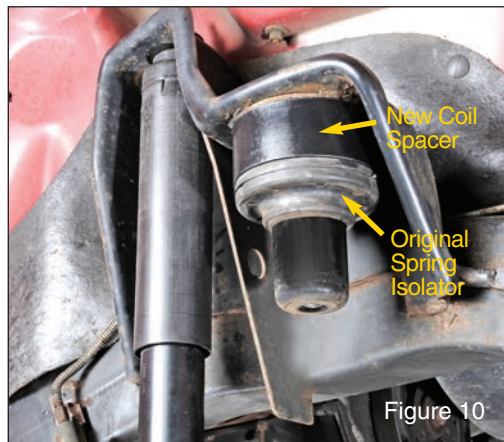

Slide down original coil spring isolator and install included coil spring spacer on top as shown (see FIG 10)



**The Trusted Source**

### 1.75" Coil Spacer Kit Installation: Front



Figure 11

*Lubricate the provided bump stop with dish soap and press it into the original bump stop cup. We found it easier to use a vice. (FIG 11)*

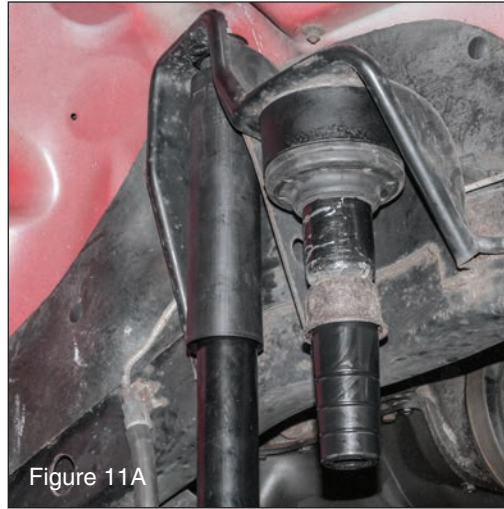

Figure 11A

*Re-attach original bump stop assembly using the original bolt, 15mm socket with ratchet extension and tighten. (FIG 11A)*

#### **CAUTION**

**INSTALL BUMP STOP SPACERS EXACTLY AS SHOWN.**

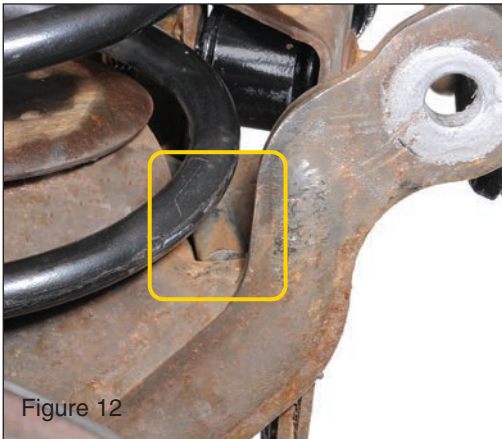

Figure 12

*Re install coil spring and index on bottom mount as shown (see FIG 12)  
Locate upper shock mount stem and*

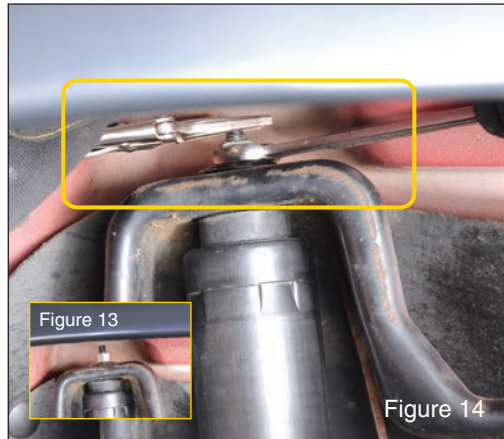

Figure 13

Figure 14

*remove using vise grips and 15mm open end wrench. (see FIG 13 & 14) Remove and discard old front shocks.*



**The Trusted Source**

## 1.75" Coil Spacer Kit Installation: Front

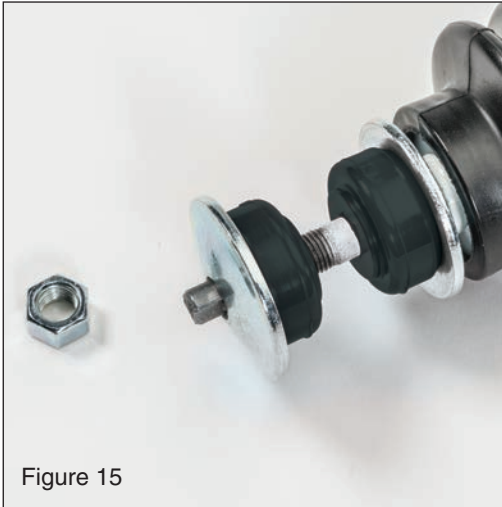

Figure 15

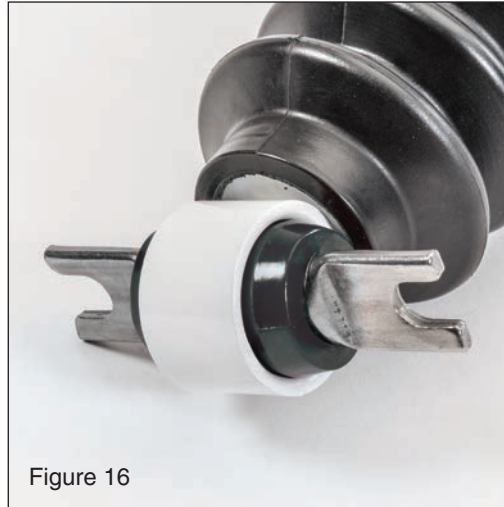

Figure 16

*Locate and assemble front shocks as shown (see FIG 15 & 16). Install into original opening at top mount and torque to 20 ft lbs using a 9/16" socket.*



*Raise the axle using a floor jack so the full weight of vehicle is on the coil springs with newly installed coil spacers.*

*Re-Attach brake line bracket to frame. Re-Attach front sway bar end links to axle housing and torque to 75 ft lbs.*

*Using factory hardware, re-attach the bottom end of the shock and torque to 21 ft lbs. Install wheels/tires and torque to 105 ft lbs.*

*Finally, remove jack stands and lower vehicle onto the ground. Re-attach track bar using factory hardware and torque to 55 ft lbs for 97-02 models and 40 ft lbs for 03-06 models.*



**The Trusted Source**

### 1.75" Coil Spacer Kit Installation: Rear

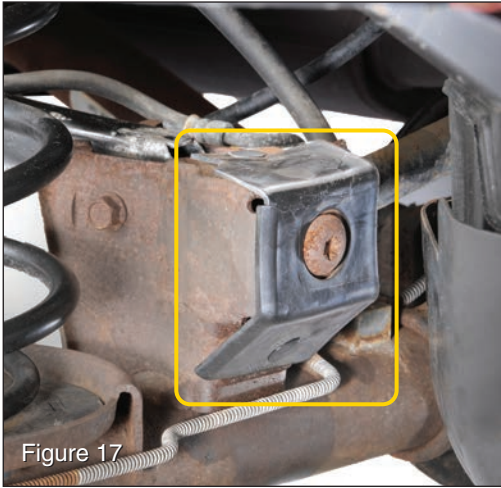

Raise rear end and properly support frame rails using jack stands. Locate rear axle track bar mount and removed plastic cover (see FIG 17) and discard.

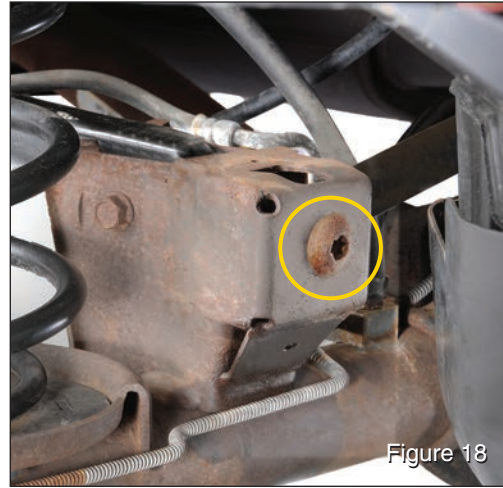

Disconnect the rear track bar from the bracket using a T55 torx socket. (see FIG 18)

#### **⚠ CAUTION ⚠**

**ALWAYS SUPPORT FRAME RAILS USING JACK STANDS. COIL SPRING MAY BE UNDER TENSION. REMOVE CAREFULLY.**

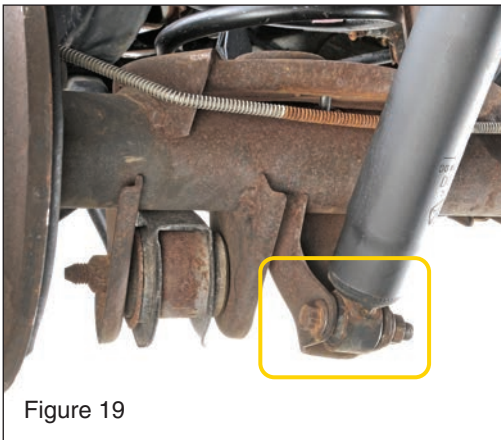

Remove rear lower shock bolts and sway bar end links using a 18mm socket and 15mm open end wrench. (see FIG 19)

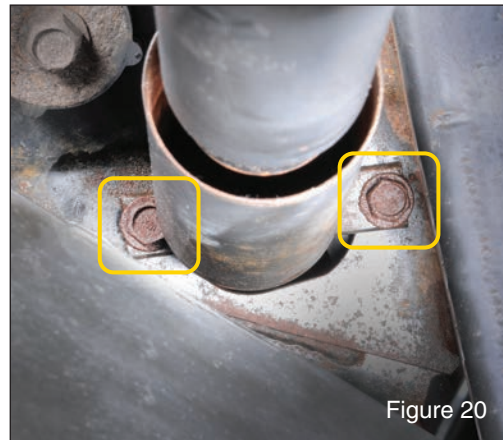

Locate rear upper shock mounting bolts and remove using 13mm socket (see FIG 20). Discard rear shocks.



**The Trusted Source**



### 1.75" Coil Spacer Kit Installation: Rear

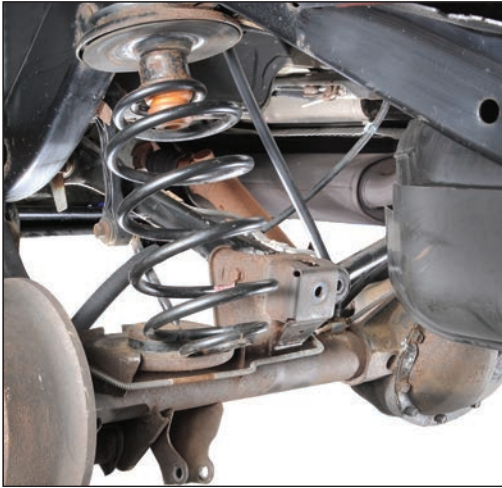

Carefully lower axle housing and remove coil springs (see FIG 21).

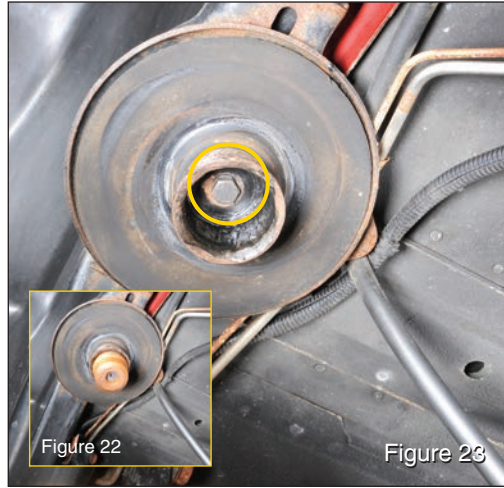

Remove original bump stop by pulling downward and twisting. (see FIG 22). Remove bump stop cup using a 15mm socket (see FIG 23)

### **CAUTION**

INSTALL COIL SPRING AND BUMP STOP SPACERS EXACTLY AS SHOWN.



Lubricate the provided bump stop with dish soap and press it into the original bump stop cup. We found it easier to use a vice. (FIG 24).



While holding the coil spacer in place, Re-attach original bump stop assembly using the original bolt, 15mm socket with ratchet extension and tighten. (FIG 25)



The Trusted Source

### 1.75" Coil Spacer Kit Installation: Rear

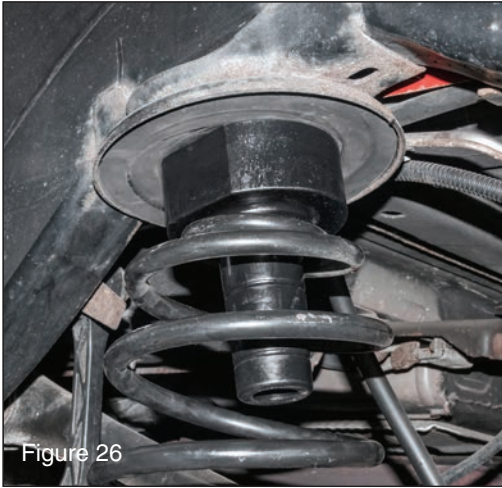

Figure 26

*Install coil spring as shown, rear springs are not indexed so alignment is not critical. (FIG 26).*

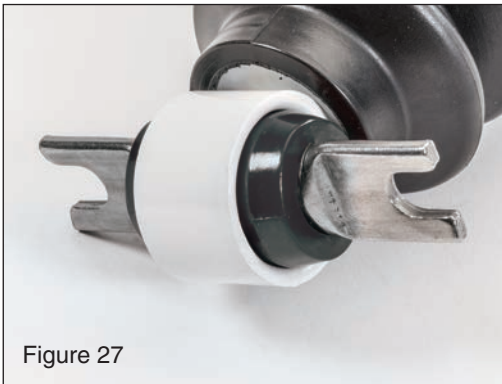

Figure 27

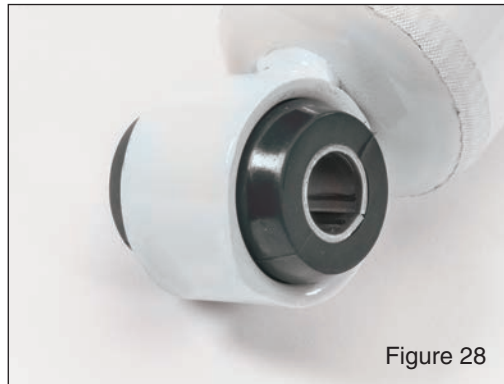

Figure 28

*Locate and assemble rear shocks as shown (see FIG 27 & 28). Install into top mount using original hardware and torque to 23 ft lbs.*



**The Trusted Source**

**1.75" Coil Spacer Kit Installation: Rear**



Re-attach rear lower shock to axle using factory hardware and torque to 74 ft lbs. Install wheels/tires and torque to 105 ft lbs. (FIG 29)

Finally, remove jack stands and lower vehicle onto the ground. Then, re-attach track bar using factory hardware and torque to 74 ft lbs.

Raise the axle using a floor jack so the full weight of vehicle is on the coil springs with new installed coil spacers.

**⚠ WARNING**

**COMPLETE INSTALLATION BY CAREFULLY INSPECTING AND CONFIRMING CLEARANCE OF CHOSEN TIRE/WHEELS THROUGH FULL STEERING SWEEP AND SUSPENSION TRAVEL. ASSURE BRAKE LINES CLEAR AND NOT RUBBING AGAINST ANY SURFACE, ABS FITTING AND OTHER FASTENERS SECURED. CHECK SPEEDOMETER READINGS AND IF NECESSARY RECALIBRATE. HAVE ALIGNMENT SETTINGS CHECKED AND IF INDICATED, RE-ALIGN AT SHOP WITH EQUIPMENT SUITED FOR MODIFIED SUSPENSION JEEP VEHICLES.**

**⚠ WARNING**

**INSTALL COCKPIT WARNING STICKER ON VISOR OR OTHER LOCATION VISIBLE TO ALL DRIVERS.**



Install cockpit warning sticker on visor or other location visible to all drivers and occupants.



**The Trusted Source**

# Quadratec® Exclusive Limited Lifetime Warranty

Your Quadratec® branded accessories are covered by the following **Limited Warranty** provided exclusively by Quadratec, Inc., 1028 Saunders Lane, West Chester PA 19380.

This Limited Warranty is the only warranty made in connection with your purchase. Quadratec neither assumes nor authorizes any vendor, retailer or other person or entity to assume for it any other obligation or liability in connection with this product or Limited Warranty. This Limited Warranty does not apply and is not cumulative to any accessory or part distributed by Quadratec for which the Manufacturer provides a separate written warranty.

**What is Covered:** Subject to the terms, exclusions and limitations herein and with respect only to Quadratec branded accessories first sold in the United States, Quadratec warrants to the initial retail purchaser only that your Quadratec accessory shall be free of defects in material and workmanship: **for as long as the original purchaser owns the vehicle. The Warranty on bushings and other serviceable wear items (including shock absorbers) is limited to 1 year from date of retail purchase.** This Limited Warranty is not assignable and shall terminate upon sale of the vehicle upon which the Quadratec accessory is installed or other transfer third persons.

All other warranties are hereby disclaimed, except to the extent prohibited by applicable law in which case any implied warranty of merchantability or fitness for a particular purpose on this limited to **for as long as the original purchaser owns the vehicle.** Quadratec reserves the rights to: (a.) require invoice or other proof your accessory is within the terms of this Limited Warranty as a condition of warranty service and, (b.) make future revisions to this product and Limited Warranty without prior notice or obligation to upgrade your product.

**What is Not Covered:**

Your Quadratec Limited Warranty does not cover products or parts Quadratec determines to have been damaged by or subjected to: (a.) installation damage, alteration, modification, combination with other parts, failure to maintain or improper repair or service, (b.) defects or use which pre-dates installation of Quadratec® accessory

or suspension kit by authorized dealer or shop, (c.) normal wear & tear or gradual reduction in expected performance of vehicle or components, (d.) emissions control or electronic stability systems or components, (e.) cosmetic damage or damage from moisture or water immersion, (f.) fleet, rental or commercial use, (g.) Acts of God, accidents, misuse, negligence, inadequate mounting or impact with vehicle(s), obstacles or other aspects of the environment, (h.) theft, vandalism or other intentional damage. (i.) use in competition or racing.

**Other Exclusions:** Surface finish of exposed suspension components is not covered under this Limited Warranty.

**Remedy Limited to Repair/Replacement:**

The exclusive remedy provided hereunder shall, upon Quadratec inspection and at Quadratec's option, be either repair or replacement of product or parts (new or refurbished) covered under this Limited Warranty. Customers requesting warranty consideration should first contact Quadratec to obtain a RGA number (610-701-3336). All labor, removal, shipping and installation costs are customer's responsibility.

**Other Limitations - Exclusion of Damages - Your Rights Under State Law:**

In consideration of the purchase price paid, neither Quadratec nor any independent Quadratec distributor/licensee are responsible for any time loss, rental costs, or for any incidental, consequential, punitive or other damages you may have or incur in connection with any part or product purchased. Your exclusive remedy hereunder for covered parts is repair/replacement as described above.

This Limited Warranty gives you specific rights. You may also have other rights that vary from state to state. For example, some states do not allow limitations of how long an implied warranty lasts and /or do not allow the exclusion or limitation of incidental or consequential damages, so the limitations and exclusions herein may not apply to you.

©Quadratec, Inc. 2019. All Rights Reserved.  
9.19.19 LTR Version Part #12999.9035



**The Trusted Source**